

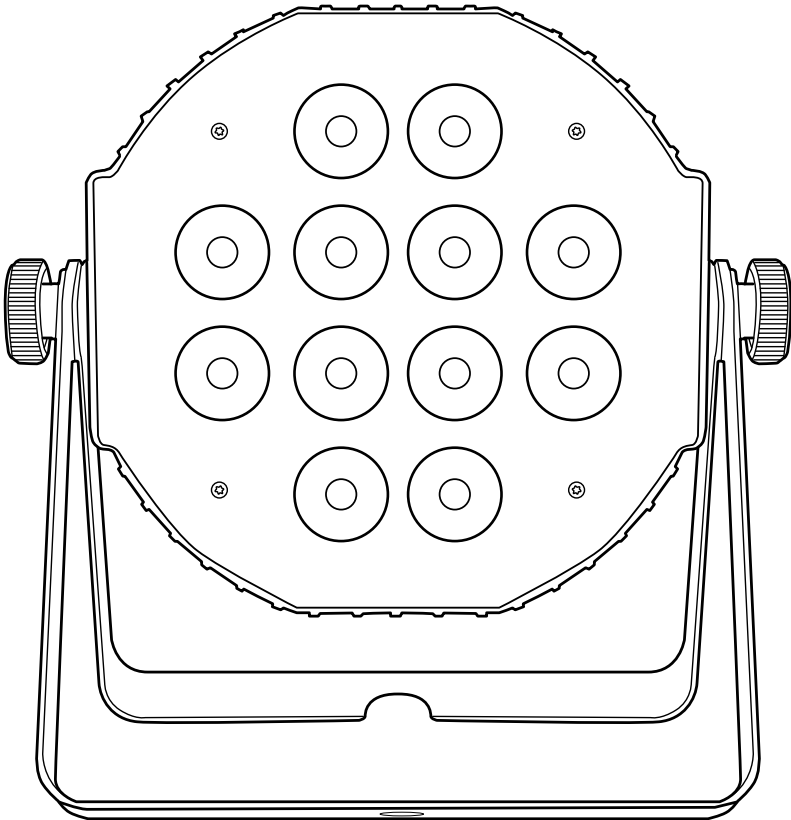

tetra 12

RGBA LED Wash Light





INTRODUCTION

The Venue Tetra 12 is a compact, yet rugged wash lighting fixture designed for mobile DJs, active bands, and venue installations. This lightweight and durable fixture is built with extra-bright 4-watt RGBA LEDs, for detailed and vibrant color mixing. This unit can be used as a standalone fixture in sound-activated mode, or controlled via DMX controller.

TABLE OF CONTENTS

BEFORE YOU BEGIN	3	Strobe (Flash)	12
What is included	3	Level (Brightness)	12
Unpacking Instructions	3	Custom Static Colors	12
Manual Conventions	3	/Manual Control	
Icons	3		
SAFETY INSTRUCTIONS	4	DMX OPERATION	13
INTRODUCTIONS	5	Configuring the Starting Address	13
Control Features	5	Master/Slave	
Additional Features	5	(Standalone Operating Modes)	13
Back Panel	5	DMX Parameters	14
SETUP	6	3-Ch mode DMX operation	14
AC Power	6	4-Ch mode DMX operation	14
Power Linking	6	5-Ch mode DMX operation	14
Mounting	7	6-Ch mode DMX operation	14
Orientation	7	DMX Map	14
Rigging	7	APPENDIX	15
Signal linking	8	DMX Primer	15
OPERATING INSTRUCTIONS	8	General Troubleshooting	15
Control Panel Menu Selections	9	Fixture Linking	16
STANDALONE OPERATION	11	DMX Data Cable	16
Static Colors	11	Cable Connectors	16
Preset Chases	11	3-Pin to 5-pin Conversion Chart	17
Speed	11	Setting Up a DMX Serial Data Link	17
Sound-Active (Audio)	12	General Maintenance	17
Audio Sensitivity (Threshold)	12	TECHNICAL SPECIFICATIONS	18
		WARRANTY	19

BEFORE YOU BEGIN

What Is Included

- Tetra 12
- Mounting Yokes
- Power Cord
- User Manual

Unpacking Instructions

Carefully unpack the carton, then check the contents to ensure that all parts are present and have been received in good condition. Notify the shipper immediately and retain packing material for inspection if any parts appear damaged from shipping, or the carton itself shows signs of mishandling. Save the carton and all packing materials. In the event that a fixture must be returned to the factory, it is important that the fixture be returned in the original factory box and packing.



Manual Conventions

Venue® manuals use the following conventions to differentiate certain types of information from the regular text.

CONVENTION	MEANING
<Menu>	Key to be pressed on the fixture's Control Display
1~512	Range of values
50/60	Set of values of which only one can be chosen
Settings	Menu option not to be modified (for example, showing the operating mode/current status)
MENU > Settings	Sequence of menu options to be followed
ON	Value to be entered or selected

Icons

This manual uses the following icons to indicate information that requires special attention on the part of the user.

ICONS	MEANING
	This paragraph contains critical installation, configuration or operation information. Failure to comply with this information may render the fixture partially or completely inoperative, cause damage to the fixture or cause harm to the user.
	This paragraph contains important installation or configuration information. Failure to comply with this information may prevent the fixture from functioning correctly.
	This paragraph reminds you of useful, although not critical, information.

SAFETY INSTRUCTIONS



Please read these instructions carefully. It includes important information about the installation, usage and maintenance of this product.

FCC Statement

1. This device complies with Part 15 of the FCC Rules. Operation is subject to the following two conditions:
 - (1) This device may not cause harmful interference, and
 - (2) This device must accept any interference received, including interference that may cause undesired operation.
2. Changes or modifications not expressly approved by the party responsible for compliance could void the user's authority to operate the equipment.

NOTE: This equipment has been tested and found to comply with the limits for a Class B digital device, pursuant to Part 15 of the FCC Rules. These limits are designed to provide reasonable protection against harmful interference in a residential installation.

This equipment generates, uses, and can radiate radio frequency energy and, if not installed and used in accordance with the instructions, may cause harmful interference to radio communications. However, there is no guarantee that interference will not occur in a particular installation. If this equipment does cause harmful interference to radio or television reception, which can be determined by turning the equipment off and on, the user is encouraged to try to correct the interference by one or more of the following measures:

Reorient or relocate the receiving antenna.

Increase the separation between the equipment and receiver.

Connect the equipment into an outlet on a circuit different from that to which the receiver is connected.

Consult the dealer or an experienced radio/TV technician for help.

- Please keep this User Manual for future reference.
- Make sure that you are connecting to the proper voltage, and that the line voltage you are connecting to is not higher than that stated on the decal or rear panel of the fixture.
- This product is intended for indoor use only! To prevent risk of fire or shock, do not expose fixture to rain or moisture.
- Make sure there are no flammable materials close to the unit while operating.
- The unit must be installed in a location with adequate ventilation, at least 20" (50 cm) from adjacent surfaces. Be sure that no ventilation slots are blocked.
- Always disconnect from the power source before servicing or replacing the fuse and be sure to replace with same type fuse.
- Secure fixture to included safety loop using a safety chain.
- Maximum ambient temperature is 104° F (40° C). Do not operate the fixture at temperatures higher than this.
- In the event of a serious operating problem, stop using the unit immediately. Never try to repair the unit yourself.
- Never connect the device to a dimmer pack.
- Make sure the power cord is never crimped or damaged.
- Never disconnect the power cord by pulling or tugging on the cord.
- Never carry the fixture directly from the cord. Always use the hanging/mounting bracket.
- Avoid direct eye exposure to the light source while it is on.

INTRODUCTIONS

Control Features

- (12x) 4-watt RGBA LEDs
- Static colors and RGBA color mixing with or without DMX controller
- Built-in automated programs via master/slave or DMX with variable speed
- Built-in sound activated programs via master/slave or DMX
- 3, 4, 5, and 6 channel DMX-512 operation
- Seamless integration with the Venue Tetra Control

Additional Features

- Power linking: 32 units @ 120V, 10A circuit max
- Dual-yoke mounting system and safety loop for stable aiming from lighting stands, trusses and floors.

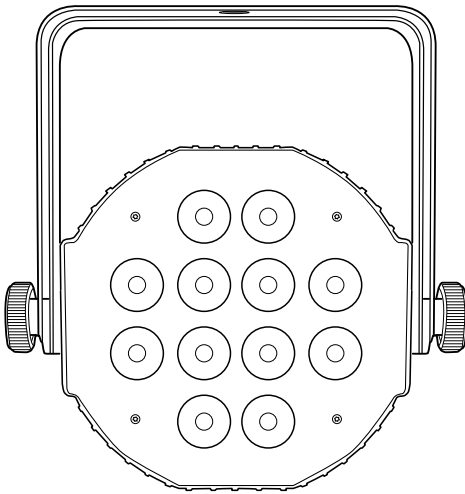

Front View

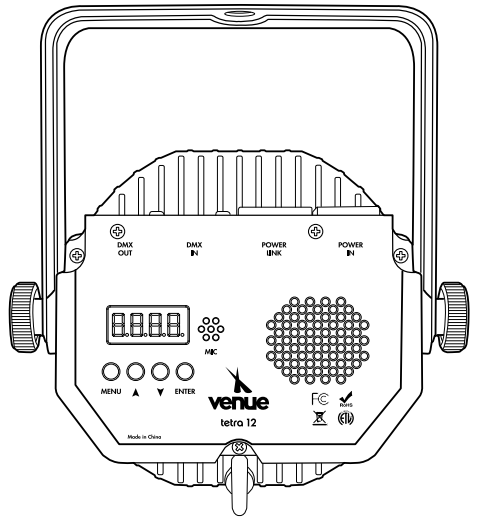

Back Panel View

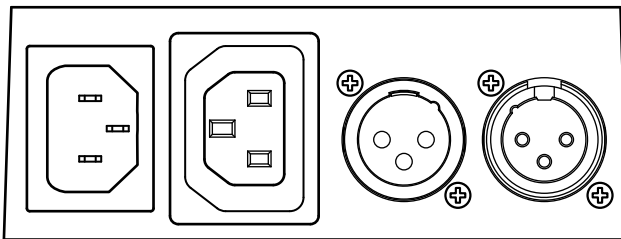

Input / Output Control Panel

SETUP

AC Power

This fixture runs on 110~120 V-60 Hz. Before powering on the unit, make sure the line voltage is within the range of accepted voltages.

To determine the power requirements for a particular fixture, see the label affixed to the bottom of the fixture or refer to the fixture's specifications chart. A fixture's listed current rating indicates its average current draw under normal conditions.



Always connect the fixture to a switched circuit. Never connect the fixture to a rheostat (variable resistor) or dimmer circuit, even if the rheostat or dimmer channel is used only as a 0 to 100% switch.



Always connect the fixture to a circuit with a suitable electrical ground.

POWER LINKING

This fixture contains power linking via the outlet located on the back panel. Please see the diagram below for further explanation.



The maximum quantity of fixtures that may be linked is 32 units @ 120V, 10A circuit max.



An IEC connection cable or male IEC adapter is required for power-linking features

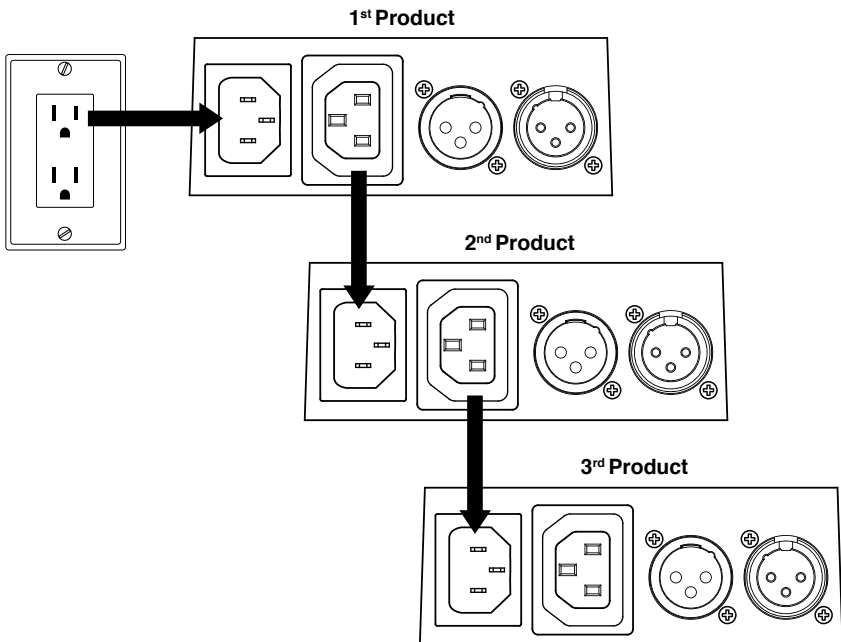

Mounting

The Tetra 12 includes a dual-yoke mounting system and safety loop for stable aiming from lighting stands, trusses and floors. Before mounting the product, read and follow the safety recommendations indicated in the Safety Notes

Orientation

The Tetra 12 may be mounted in any position; however, make sure adequate ventilation is provided around the product.

Rigging

Be sure that the structure can support the weight of the fixture. Please see the “Technical Specifications” section of this manual for a detailed weight listing. Mount the fixture securely. This may be done with a screw, nut and bolt, or a hanging clamp (not included). The hole in each bracket can fit a ½ in. screw or bolt. When rigging, consider routine maintenance and back panel access. Please see the following steps for installation.

- Before deciding on a location for the product, always make sure there is easy access to the product for maintenance and programming purposes.
- Make sure that the structure onto which you are mounting the product can support the product’s weight. See the Technical Specifications for weight information.
- When mounting the product overhead, always use a safety cable. Mount the product securely to a rigging point, whether an elevated platform or a truss.
- When rigging the product onto a truss, use a mounting clamp of appropriate weight capacity.
- When power linking multiple products, mount the products close enough for power linking cables to reach.
- The bracket adjustment knobs allow for directional adjustment when aiming the product to the desired angle. Only loosen or tighten the bracket knobs manually. Using tools could damage the knobs.

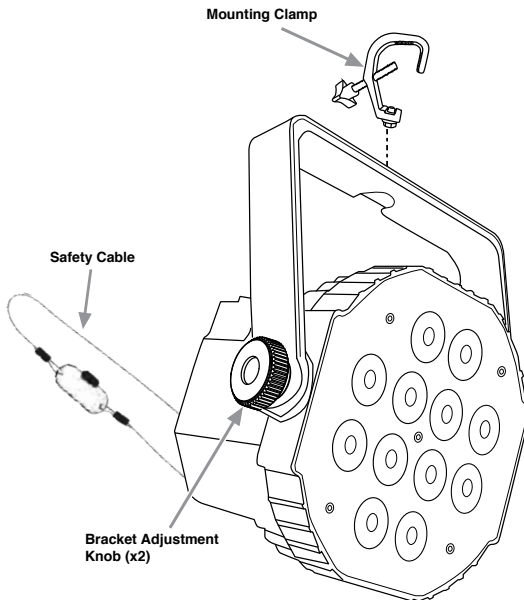

Signal Linking

In order to use this fixture in a DMX or master/slave operation, you must daisy chain using DMX cables to link from one fixture to another.

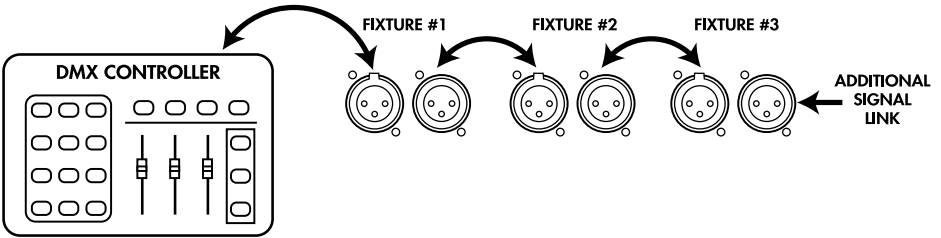

OPERATING INSTRUCTIONS

Control Panel Buttons

Access these functions using the four buttons located directly underneath the LED Control Display.

BUTTON	FUNCTION
<Menu>	Scrolls through the current operating mode, as well as back out of the current menu option
<UP>	Selects increasing advancement in the value
<DOWN>	Selects decreasing advancement in the value
<ENTER>	Selects a value and stores it to memory

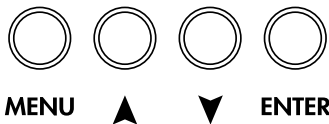
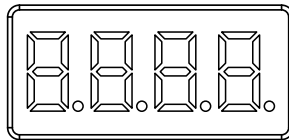

The Control Display shows the current state of the unit. It is used to select the operating mode, as well as the sub-features. For detailed functions, please see the section below.

Control Panel Menu Selections

	MAIN FUNCTION	SUB-FUNCTION	INSTRUCTION
Identity	I	3c	Select between 3-channel, 4-channel, 5-channel, and 6-channel DMX modes.
		4c	
		5c	
		6c	
Utility	U	d0	Enable display sleep mode, turning off the menu display after 30 seconds of no menu input.
		d1	Disable display sleep mode, keeping the menu display lit at all times.
Manual Color Mixing	MANU	r0-255	Manually alter color balance, specifying values between 0-255 for all options.
		G0-255	
		b0-255	
		o0-255	
Static Color	C	1	Select static color: Red
		2	Select static color: Green
		3	Select static color: Blue
		4	Select static color: Yellow
		5	Select static color: Pink
		6	Select static color: Turquoise
		7	Select static color: Lime
		8	Select static color: Orange
		9	Select static color: Marine
		10	Select static color: Lavender
		11	Select static color: Candy
		12	Select static color: Leaf
		13	Select static color: Purple
		14	Select static color: White
Patterns/Chases	P	C0	Select pre-programmed switching chases 0-9
		C1	
		C2	
		C3	
		C4	

Control Panel Menu Selections (Continued)

	MAIN FUNCTION	SUB-FUNCTION	INSTRUCTION
Patterns/Chases	P	C5	Select pre-programmed switching chases 0-9
		C6	
		C7	
		C8	
		C9	
		F0	Select pre-programmed fading chases 0-9.
		F1	
		F2	
		F3	
		F4	
		F5	
		F6	
		F7	
		F8	
		F9	
		Audio/Sound-Active Programs	
C1			
C2			
C3			
C4			
C5			
C6			
C7			
C8			
C9			
F0	Select sound-active fading chases 0-9.		
F1			
F2			
F3			
F4			
F5			

Control Panel Menu Selections (Continued)

	MAIN FUNCTION	SUB-FUNCTION	INSTRUCTION
Audio/Sound-Active Programs	A	F6	Select sound-active fading chases 0-9.
		F7	
		F8	
		F9	
Flash/Strobe	F	1-14	Enable strobe, and select strobe color. Reference static colors above for corresponding numbers. Strobe speed can be adjusted using the speed ("S") parameter.
DMX Address	d	1-512	Select starting DMX address.
Level/Brightness	L	1-99	Select brightness level between 1 (lowest level) and 99 (highest level).
Speed	S	1-10	Select speed of internal programs. This applies to Pattern and Strobe functions.
Threshold/Audio Sensitivity	t	1-10	Select sensitivity level of the internal microphone between 1 (most sensitive) and 10 (least sensitive).

STANDALONE OPERATION

STATIC COLORS

This fixture has 14 distinct, pre-programmed static colors. Refer to the "Control Panel Menu Selections" chart on page 9 for a list of colors. These are accessed via the Control Display (page 8).

1. Press **<MENU>** until "**C-**" are the first two characters on the display screen.
2. Using **<UP>** and **<DOWN>**, select the desired color (1-14).
3. Press **<ENTER>** to confirm settings.

PRESET CHASES

This fixture has 20 pre-programmed chases (10 switching and 10 fading). These are accessed via the Control Display (page 8).

4. Press **<MENU>** until "**P-**" are the first two characters on the display screen.
5. Using **<UP>** and **<DOWN>**, select the desired program (C0-C9 for switching chases, or F0-F9 for fading chases).
6. Press **<ENTER>** to confirm settings.

SPEED

The speed of internal chases and strobe functions can be adjusted from 1 (slowest) to 10 (quickest). This setting is accessed via the Control Display (page 8).

1. Press **<MENU>** until "**S-**" are the first two characters on the display screen.
2. Using **<UP>** and **<DOWN>**, select the desired speed between 1 (slowest) and 10 (quickest).
3. Press **<ENTER>** to confirm settings.

STANDALONE OPERATION

SOUND-ACTIVE (AUDIO)

This fixture has 20 pre-programmed chases (10 switching and 10 fading) that use the built-in microphone for sound-active response. These are accessed via the Control Display (page 8).

1. Press **<MENU>** until "**A-**" are the first two characters on the display screen.
2. Using **<UP>** and **<DOWN>**, select the desired program (C0-C9 for switching chases, or F0-F9 for fading chases).
3. Press **<ENTER>** to confirm settings.

AUDIO SENSITIVITY (THRESHOLD)

At any time, you can adjust the sensitivity of the microphone for use alongside sound-active programs, via the Control Display (page 8).

1. Press **<MENU>** until "**t-**" are the first two characters on the display screen.
2. Press **<UP>** or **<DOWN>** to adjust the sensitivity between 1 and 10 (1 = most sensitive, 10 = least sensitive)
3. Press **<ENTER>** to save your sensitivity setting.

STROBE (FLASH)

This fixture includes a strobe mode, with 14 color options. Refer to the "Control Panel Menu Selections" chart on page 9 for a list of colors. The speed of the strobe can be adjusted via the Speed parameter described above. This mode is accessed via the Control Display (page 8).

4. Press **<MENU>** until "**F-**" are the first two characters on the display screen.
5. Press **<UP>** or **<DOWN>** to select the desired strobe color (1-14).
6. Press **<ENTER>** to confirm settings.

LEVEL (BRIGHTNESS)

The brightness of standalone functions can be adjusted via the Level parameter. This setting is accessed via the Control Display (page 8).

7. Press **<MENU>** until "**L-**" are the first two characters on the display screen.
8. Press **<UP>** or **<DOWN>** to select the desired brightness setting (1 = least bright, 99 = most bright).
9. Press **<ENTER>** to confirm settings.

CUSTOM STATIC COLORS / MANUAL CONTROL

This fixture has the ability to accept custom static color settings via the Control Display (page 8).

1. Press **<MENU>** until "**MANU**" appears on the display screen.
2. Press **<ENTER>**.
3. Using **<UP>** and **<DOWN>**, select the desired level for the red LEDs (r0-255)
4. Repeat steps 2-3 for green, blue, and amber (G0-255, b0-255, o0-255) until the desired color is obtained.
5. Press **<ENTER>** after all color selections to exit back to the main menu.

DMX OPERATION

This is the operating mode which will allow for an external DMX controller. You must set the starting address for this mode. If this is your first time using DMX, then it is recommended that you refer to the "DMX Primer" section in the "Appendix" of this manual. Start by selecting the DMX personality for the fixture by following the steps below:

1. Press **<MENU>** until "I-" are the first two characters on the display screen
2. Using **<UP>** and **<DOWN>**, select either "3c", "4c", "5c" or "6c".
3. Press **<ENTER>**.

CONFIGURING THE STARTING ADDRESS

Each fixture requires a starting address from 1-512. A fixture requiring one or more channels for control begins to read the data on the channel indicated by the starting address. For example, a fixture that uses six DMX channels and is addressed to start on DMX channel 100, will read data from channels: 100, 101, 102, 103, 104, and 105. Choose the starting addresses for each fixture so that the channels used do not overlap. In addition, you should note the starting address selected for future reference.

1. Press **<MENU>** until "d" is the first character on the display screen.
2. Using **<UP>** and **<DOWN>**, select the desired DMX address (1-512).
3. Press **<ENTER>** to confirm starting address.

MASTER/SLAVE (STANDALONE OPERATING MODES)

The Master/Slave mode allows a single fixture (the "Master") to control the actions of one or more other fixtures (the "Slaves") without the need of a DMX controller. The Master product will be set to operate in Stand-Alone mode, while the Slave products will be set to operate in Slave mode. Once set and connected, the Slave fixtures will operate in unison with the Master fixture. Master/Slave mode is only available for use with Identities: 3c (RGB) and 4c (RGBA). Configure the products as indicated below.

Slave fixture:

1. Press **<MENU>** repeatedly until "I-" are the first two characters on the display screen.
2. Select a DMX personality (3c or 4c) that matches the master fixture.
3. Press **<ENTER>** to confirm.
4. Set the DMX address to d 1, by pressing **<MENU>** until "d" is the first character on the screen, and using **<UP>** and **<DOWN>** to navigate to the correct starting address.
5. Connect the DMX input of the first Slave product to the DMX output of the Master product.
6. Connect the DMX input of the subsequent Slave products to the DMX output of the previous Slave product.
7. Finish setting and connecting all the Slave products.

Master fixture:

1. Set the Master fixture to operate in Stand-Alone mode.
2. Make the Master fixture the first product in the DMX daisy chain.



Although any fixture in the DMX daisy chain may be set to master, it is advisable to set the master as the first fixture in the line.



Only one fixture may be set to master.



Do not connect a DMX controller to the daisy chain for this operating mode.



It does not matter which DMX mode is selected for the slave fixtures. Either mode will be effective.

DMX Parameters

3-CH DMX Mode	
Channel	Channel Function
1	Red
2	Green
3	Blue

4-CH DMX Mode	
Channel	Channel Function
1	Red
2	Green
3	Blue
4	Amber

5-CH DMX Mode	
Channel	Channel Function
1	Red
2	Green
3	Blue
4	Amber
5	Dimmer/Strobe

6-CH DMX Mode	
Channel	Channel Function
1	Red
2	Green
3	Blue
4	Amber
5	Dimmer
6	Strobe

DMX Map

FUNCTION	VALUE	PERCENT/SETTING	MODE 3 CH	MODE 4 CH	MODE 5 CH	MODE 6 CH
Red	0-255	0~100%	1	1	1	1
Green	0-255	0~100%	2	2	2	2
Blue	0-255	0~100%	3	3	3	3
Amber	0-255	0~100%		4	4	4
Dimmer/Strobe	0-127 128-227 228-255	Master dimmer Strobe (128=slow / 227=max. speed, 23Hz) Master dimmer at 100%, Strobe off			5	
Dimmer	0-255	0~100%				5
Strobe	0-255	0~100%				6

APPENDIX

DMX PRIMER

There are 512 channels in a DMX connection. Channels may be assigned in any manner. A fixture capable of receiving DMX will require one or a number of sequential channels. The user must assign a starting address on the fixture that indicates the first channel reserved in the controller. There are many different types of DMX controllable fixtures and they all may vary in the total number of channels required. Choosing a start address should be planned in advance. Channels should never overlap. If they do, this will result in erratic operation of the fixtures whose starting address is set incorrectly. You can however, control multiple fixtures of the same type using the same starting address as long as the intended result is that of unison movement or operation. In other words, the fixtures will be slaved together and will all respond exactly the same. Consult the Owner's Manual to your DMX controller for more information.

DMX fixtures are designed to receive data through a serial Daisy Chain. A Daisy Chain connection is where the DATA OUT of one fixture connects to the DATA IN of the next fixture. The order in which the fixtures are connected is not important and has no effect on how a controller communicates to each fixture. Use an order that provides for the easiest and most direct cabling. Connect fixtures using shielded two-conductor twisted pair cable with three pin XLR male to female connectors. The shield connection is pin 1, while pin 2 is Data Negative (S-), and pin 3 is Data Positive (S+).

General Troubleshooting

SYMPTOM	POSSIBLE CAUSE(S)	POSSIBLE ACTION(S)
Breaker/Fuse keeps blowing	<ul style="list-style-type: none"> Excessive circuit load Short circuit along the power wires 	<ul style="list-style-type: none"> Check total load placed on the electrical circuit Check for a short in the electrical wiring (internal and/or external)
Device does not power up	<ul style="list-style-type: none"> No power Loose power cord 	<ul style="list-style-type: none"> Check for power on Mains Check power cord
Fixture is not responding to DMX	<ul style="list-style-type: none"> Wrong DMX addressing Damaged DMX cables Wrong polarity settings on the controller Loose DMX cables Faulty DMX interface Faulty Main PCB 	<ul style="list-style-type: none"> Check Control Display and unit addressing Check DMX cables Check polarity switch settings on the controller Check cable connections Replace DMX input Replace Main PCB
Loss of signal	<ul style="list-style-type: none"> Non DMX cables Bouncing signals Long cable / Low level signal Too many fixtures Interference from AC wires 	<ul style="list-style-type: none"> Use only DMX compatible cables Install terminator as suggested Install amplifier right after fixture with strong signal Install an optically coupled DMX splitter after unit #32 Keep DMX cables separated from power cables or black light

FIXTURE LINKING

You will need a serial data link to run light shows of one or more fixtures using a DMX controller or to run synchronized shows on two or more fixtures set to a master/slave operating mode. The combined number of channels required by all the fixtures on a serial data link determines the number of fixtures the data link can support.



Fixtures on a serial data link must be daisy chained in one single line. To comply with the EIA-485 standard, no more than 32 fixtures should be connected on one data link. Connecting more than 32 fixtures on one serial data link without the use of a DMX optically-isolated splitter may result in deterioration of the DMX signal.

Maximum recommended serial data link distance: 500 m (1640 ft)
Maximum recommended number of fixtures on a serial data link: 32

DMX Data Cable

Use a cable which meets the specifications for EIA RS-485 applications. Standard microphone cables cannot transmit DMX data reliably over long distances. The cable must have the following characteristics:

Type:	Shielded, 2-conductor, twisted pair
Maximum capacitance between conductors:	30 pF/ft
Maximum capacitance between conductor and shield:	55 pF/ft
Maximum resistance:	20 Ohms/1000 ft
Nominal impedance:	100 ~ 140 Ohms

Cable Connectors

Cabling must have a male XLR connector on one end and a female XLR connector on the other end.

DMX CONNECTOR CONFIGURATION

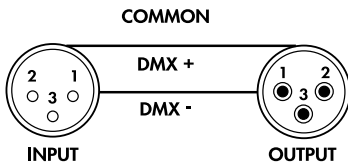

TERMINATOR



To avoid signal transmissions problems and interference, it is always advisable to connect a DMX signal terminator.

120 ohm 1/4 W resistor between pin 2 (DMX-) and pin 3 (DMX+) on the output of the last fixture



Do not allow contact between the common and the fixture's chassis ground. Grounding the common can cause a ground loop, and your fixture may perform erratically. Test cables with an Ohm meter to verify correct polarity and to make sure the pins are not grounded or shorted to the shield or each other.

3-Pin To 5-Pin Conversion Chart



If you use a controller with a 5-pin DMX output connector, you will need to use a 5-pin to 3-pin adapter. The chart below details a proper cable conversion:

3-PIN TO 5-PIN CONVERSION CHART		
Conductor	3-Pin Female (Output)	5-Pin Male (Input)
Ground/Shield	Pin 1	Pin 1
Data (-) Signal	Pin 2	Pin 2
Data (+) Signal	Pin 3	Pin 3
Not Used		Pin 4
Not Used		Pin 5

Setting Up A DMX Serial Data Link

1. Connect the (male) 3-pin connector side of the DMX cable to the output (female) 3-pin connector of the controller.
2. Connect the end of the cable coming from the controller which will have a (female) 3-pin connector to the input connector of the next fixture consisting of a (male) 3-pin connector.
3. Then, proceed to connect from the output as stated above to the input of the following fixture and so on.

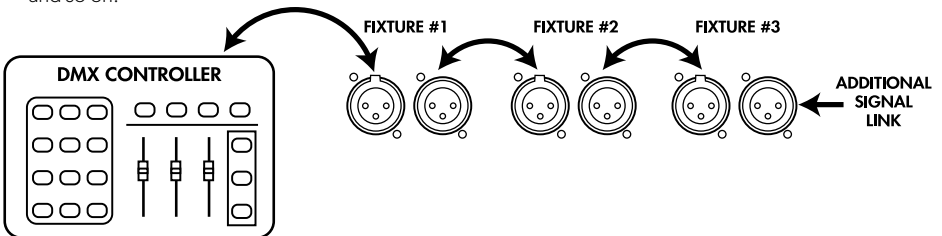

General Maintenance

To maintain optimum performance and minimize wear, fixtures should be cleaned frequently. Usage and environment are contributing factors in determining frequency. As a general rule, fixtures should be cleaned at least twice a month. Dust reduces performance and can cause overheating. This can lead to reduced lamp life and increased mechanical wear. Be sure to power off fixture before conducting maintenance.

- Unplug fixture from power.
- Use a vacuum or air compressor and a soft brush to remove dust collected on external vents.
- Clean all glass when the fixture is cold with a mild solution of glass cleaner or Isopropyl Alcohol and a soft lint-free cotton cloth or lens tissue.
- Apply solution to the cloth or tissue and drag dirt and grime to the outside of the lens.
- Gently polish optical surfaces until they are free of haze and lint.

The cleaning of external optical lenses and/or mirrors must be carried out periodically to optimize light output. Cleaning frequency depends on the environment in which the fixture operates. Damp, smoky or particularly dirty surroundings can cause greater accumulation of dirt on the unit's optics. Clean with soft cloth using normal glass cleaning fluid. Clean the external optics at least every 20 days. Clean the fixture at least every 30/60 days.



Always dry parts carefully after cleaning them.



Never spin a fan using compressed air.

TECHNICAL SPECIFICATIONS

Weight & Dimensions

Length	9.05" (230mm)
Width	7.08" (180mm)
Height	3.70" (94mm)
Weight	4.73 lbs (2.15 kg)

Power

Auto-ranging power supply	100-120V~60 Hz
Power Consumption @ 120 V	36 W max, 1 A inrush
Power output	32 units @ 120V, 10A circuit max

Light Source

LEDs	x12 (4-watt, RGBA)
Lux @ 2m	2,700
Beam Angle	15°
Field Angle	30°

DMX

DMX Channels	3/4/5/6
DMX Connectors	3-pin XLR

Thermal

Maximum ambient temperature	104° F (40° C)
Cooling	Convection

WARRANTY

One (1) Year Limited Warranty

Subject to the limitations set forth below, Venue® hereby represents and warrants that the components of this product shall be free from defects in workmanship and materials, including implied warranties of merchantability or fitness for a particular purpose, subject to normal use and service, for one (1) year to the original owner from the date of purchase.

Retailer and manufacturer shall not be liable for damages based upon inconvenience, loss of use of product, loss of time, interrupted operation or commercial loss or any other incidental or consequential damages including but not limited to lost profits, downtime, goodwill, damage to or replacement of equipment and property, and any costs of recovering, reprogramming, or reproducing any program or data stored in equipment that is used with Venue® products. This guarantee gives you specific legal rights. You may have other legal rights which vary from state to state. Some states do not allow limitations on how long an implied warranty lasts, so the above limitation may not apply to you.

Venue Lighting Effects

P.O. Box 5111, Thousand Oaks, CA 91359-5111

www.venuelightingeffects.com

All trademarks and registered trademarks mentioned herein are recognized as the property of their respective holders.

Made in China

1911-19356280

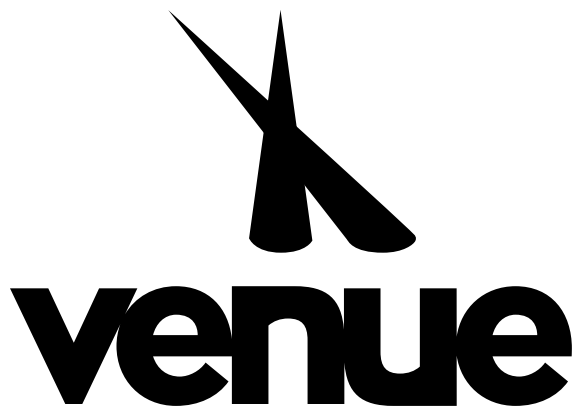

www.venuelightingeffects.com